

NEW FOR 2022

Digital Light Processing (DLP)

This comprehensive guide provides a technical overview of DLP printing, along with the latest information on innovations in machine design, from bottom-up to top-down printing — as well as new types of photopolymer resins that deliver durable, elastomeric material properties, including closed-cell foams.

Inside, you'll learn:

- Why DLP is the fastest, smartest way to 3D print with light
- About the latest updates in DLP printer designs
- Why a new category of DuraChain™ resins is a breakthrough
- Important considerations for DLP light engines
- Why DLP technology is ready for volume production of end-use parts

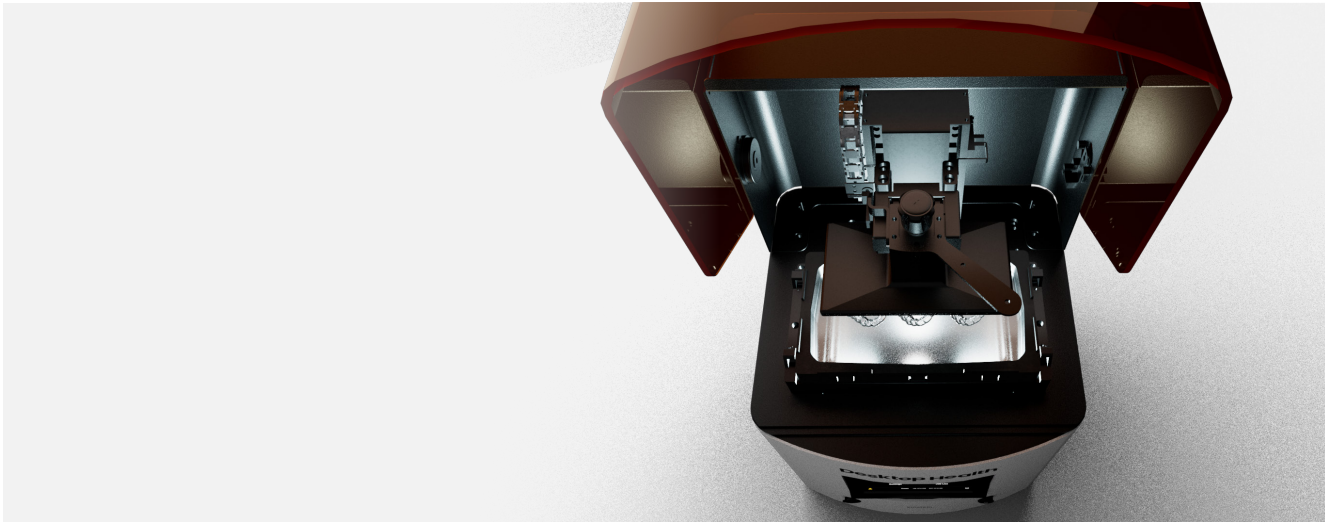

Introduction

Digital Light Processing, or DLP, harnesses the power of light from a video projector to cure photosensitive liquid resins into parts layer by layer, one quick flash at a time.

A 3D printing process that's been used since 1999, DLP was invented as a significant speed advancement over stereolithography, or SLA, which cures photosensitive resin with UV light from a laser beam, drawing parts out individually one layer at a time.

More than 20 years later, DLP is one of the more mature processes in the field of 3D printing. Today, this highly affordable, accurate and high-speed printing technology is used for everything from prototyping to volume production of end-use parts, including those with demanding precision, surface finish, and functional requirements. Initially used for the production of mass-customized hearing aid shells and functional dental restorations, such as dentures and crowns that go right in the mouth for biting and chewing, the technology is now used widely in manufacturing for tooling and casting applications as well as for direct production across a wide range of industries and end-use applications.

In fact, the speed and accuracy of DLP printing is now so powerful that it has truly become a standard manufacturing tool. An increasing number of dentists, audiologists, jewelers and industrial manufacturers use DLP printers in their offices or on their factory floors — demonstrating the potential of this fast and accurate polymer printing technology to transform manufacturing, not only for customized parts but for on-demand replacement of spare parts and serial production needs. When the COVID pandemic started sweeping the globe in late 2019, it was often DLP printers that filled the urgent demand for production of nose swabs and valves for respirators.

New Developments in DLP

Over these past two decades, the landscape of DLP technology offerings has also dramatically changed – from the mechanical design of the printing systems and the processing strategies used, to the materials they process.

While there are now more DLP printers than ever available at affordable prices, the premium end of the market for serious manufacturers has continued to innovate in ways that enable DLP to advance into the volume production of end-use parts, or Additive Manufacturing 2.0. Industrial-grade DLP systems can now crank out durable, end-use parts with volumes and costs that compete with traditional manufacturing while offering once-impossible design and supply chain advantages for which 3D printing is well known.

While improvements in machine design have played a key role in enabling this next era of DLP printing, advances in material properties have been equally critical, if not more so. For a long time, DLP printing produced incredibly smooth and accurate parts that were also fairly brittle, shattered easily, or experienced diminishing performance and mechanical properties over time.

The competitive field of material science has raced to solve these challenges, especially as adoption of DLP printers has surged in the market. Now, with innovations such as DuraChain resins, DLP can produce tough and durable elastomers that compete with thermosets — delivering rubber- and silicone-like properties, even a true closed-cell foam.



—
DLP printing is used widely for precision medical applications. E-Guide, shown here printing on a Desktop Health printer, is a biocompatible certified Class I material used for precision surgical drill guides used for implant surgery.

This white paper is a comprehensive overview of the fast-changing DLP marketplace, updated for 2022, with a quick overview of the past and a deep dive on the most significant machine and material advances of today.

At Desktop Metal, our team is passionate in the belief that DLP is one of the few 3D printing process technologies capable of driving the Additive Manufacturing 2.0 revolution, where the many benefits of 3D printing — less waste, sustainable

on-demand production, and lightweight and innovative designs — can be delivered at more meaningful mass production volumes at costs competitive with traditional manufacturing.

The History of DLP

Simply put, DLP was born out of the limitations of stereolithography, or SLA, the first commercialized 3D printing technology, which cures photosensitive resin with UV light from a laser beam.

Within the seven categories of 3D printing recognized by the ASTM, both SLA and DLP are classified together under vat photopolymerization, or VPP, in which light sources are used to cure photopolymer resin in a vat.

As is often the case with new technologies, several innovators around the world found themselves exploring a similar SLA approach around the same time in the early 1980s. Japanese researcher Hideo Kodama investigated using the method to create prototypes at about the same time a trio of French researchers were looking at a method of using light to cure liquid monomers into solids using a laser. But it was Charles Hull in the United States – looking for an affordable way to make small plastic parts quickly and affordably – who first delivered a commercial solution. In 1986, he filed a patent for a system of creating 3D models by using a laser to cure photosensitive resins layer by layer. In 1988, he founded 3D Systems Corp., which sold its first SLA-1 printer that year.

While SLA was a breakthrough process at the time and is still highly relevant today, it was – and remains – a relatively slow method of 3D printing. After build prep software slices a part design into hundreds and sometimes thousands of design layers, a laser beam has to draw those designs out one part at a time, layer by layer. This vector-based method of 3D printing, similar to drawing each layer with a fine-point pen, can be painstakingly slow.

Early SLA printers also created parts with visible layer lines on the surface that clearly demarcated each layer. In addition, printer build areas were limited because the laser beam would elongate at the far edges of the build area — much like the beam from a flashlight elongates when directed to a faraway point on a wall versus a tighter beam when aimed directly at a wall. The resulting distortion impeded accuracy and surface finish for larger builds.

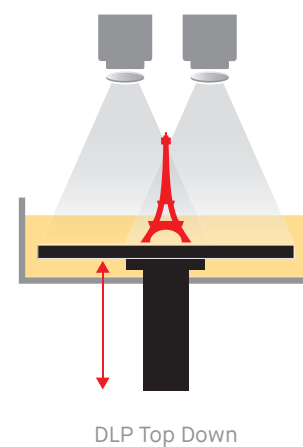
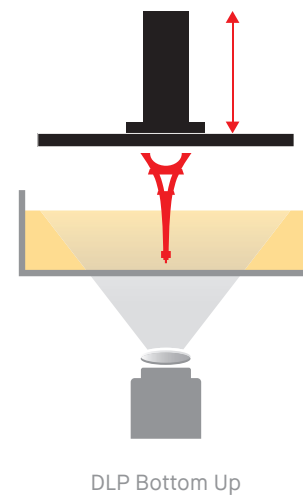
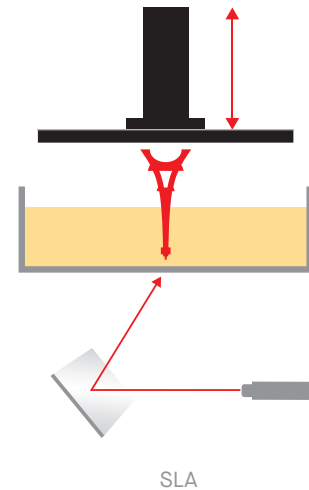

DLP is Born as a Problem Solver

A solution to those problems presented itself soon after the invention of a novel projector chip by Larry Hornbeck, a fellow at Texas Instruments. Hornbeck invented the Digital Micromirror Device or DMD, an optical semiconductor with as many as 2 million movable and individually controllable micro mirrors for directing light. Today, the DMD, with 8 million native pixels, is used in a wide range of digital display products, from HDTVs to projectors for commercial movie theaters.

Texas Instruments began working on this technology in the late 1970s, and the DMD was formally invented in 1987. However, it wasn't until 1999 that the so-called DLP chip made its commercial debut with "Star Wars: Episode 1 - the Phantom Menace" — the first full-length motion picture shown with a DMD, which what was commercially branded DLP Cinema technology. DLP® and DLP Cinema® are both trademarks of Texas Instruments.

While DLP was lauded as a technology breakthrough for the entertainment industry at the time, it didn't take long for insiders in the still-young 3D printing industry to quickly realize that UV light smartly projected by a DLP chip could cure a whole layer of resin at once in a single flash – significantly faster than with a laser as the light source. This area-wide approach to 3D printing would bring new efficiencies and quality to the field of VPP.

Just as with SLA, innovators on different continents began working on this concept at around the same time. In Germany, a team at EnvisionTEC GmbH began development, as did two longtime 3D printing colleagues in the United States, who unveiled a functional prototype in 1999. Eventually, the European and American teams would come

together under the EnvisionTEC brand to launch the Perfactory DLP printer in 2002.

The speed of the Perfactory DLP printer and the high quality of the surface finish and edges it could deliver — similar to the smooth resolution on a cinema screen — rocketed DLP into the annals of a standard 3D printing technologies.

ASTM Recognized 3D Printing Methods

AM encompasses seven distinctly different process characterizations as defined in the ISO / ASTM 52900 standard. Each is defined by the form of feedstock and/or the binding process used to bind the materials.

1. Binder Jetting (BJT)
2. Directed Energy Deposition (DED)
3. Material Extrusion (MEX)
4. Material Jetting (MJT)
5. Powder Bed Fusion (PBF)
6. Sheet Lamination (SHL)
7. Vat Photo Polymerization (VPP)

—
Photo of the individually controllable micro mirrors on a DMD chip, a technology branded by Texas Instruments as DLP®. Learn more at TeamDM.com/DMDchip



The Benefits of Area-Wide 3D Printing

Importantly, DLP stands out today for the same reason it did then: area-wide 3D printing, which translates into speed.

In SLA printing, adding parts to a build increases the time it takes to cure each layer because the laser has to trace out the contours and interiors of each additional part. With DLP, however, each area-wide flash takes exactly the same amount of time regardless of how many parts are in the build. As a result, total print time is less dependent on the quantity of parts in a build and more dependent on the height of a build, which determines how many layers will need to be exposed to complete the job.

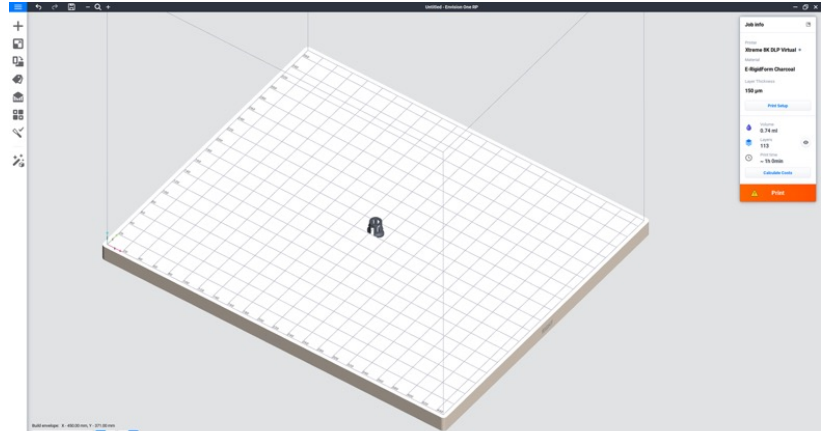

Among the many methods of 3D printing, there are only two mature area-wide processes that can complete a full area-wide layer in one flash or quick pass: DLP and binder jetting technology (BJT), during which an inkjet printhead selectively deposits binder into powder material in a quick pass over the build area.

Most of the remaining methods — material extrusion, material jetting, powder bed fusion, directed energy deposition and sheet lamination — draw out parts with a single point, usually a laser beam or a nozzle. Today, many systems using these processes do feature multiple lasers or nozzles, but they are still effectively tracing out parts layer by layer with what amounts to multiple fine-tip pens versus processing a whole layer at once, making these processes relatively slower. These single-point methods also come with other drawbacks, as material is bound at different times, often creating breakpoints in parts or, in the case of FDM, areas where clearly delineated layers may not be watertight. As yet another drawback of these alternative 3D printing processes, additional lasers or nozzles adds cost to the printers, compounding the impact of the slow speeds on part economics.

Area-wide printing is simply a more effective strategy for processing layers with the speed to deliver the throughput and costs that manufacturers require to use 3D printing for volume production.

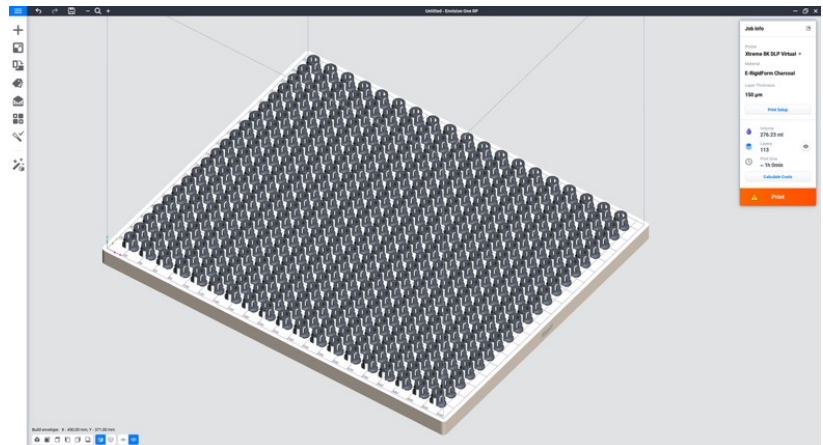

Comparison of the build time required to print one fuel clip vs a build with 380 parts. With DLP, both prints would be complete in just one hour, regardless of part quantity.

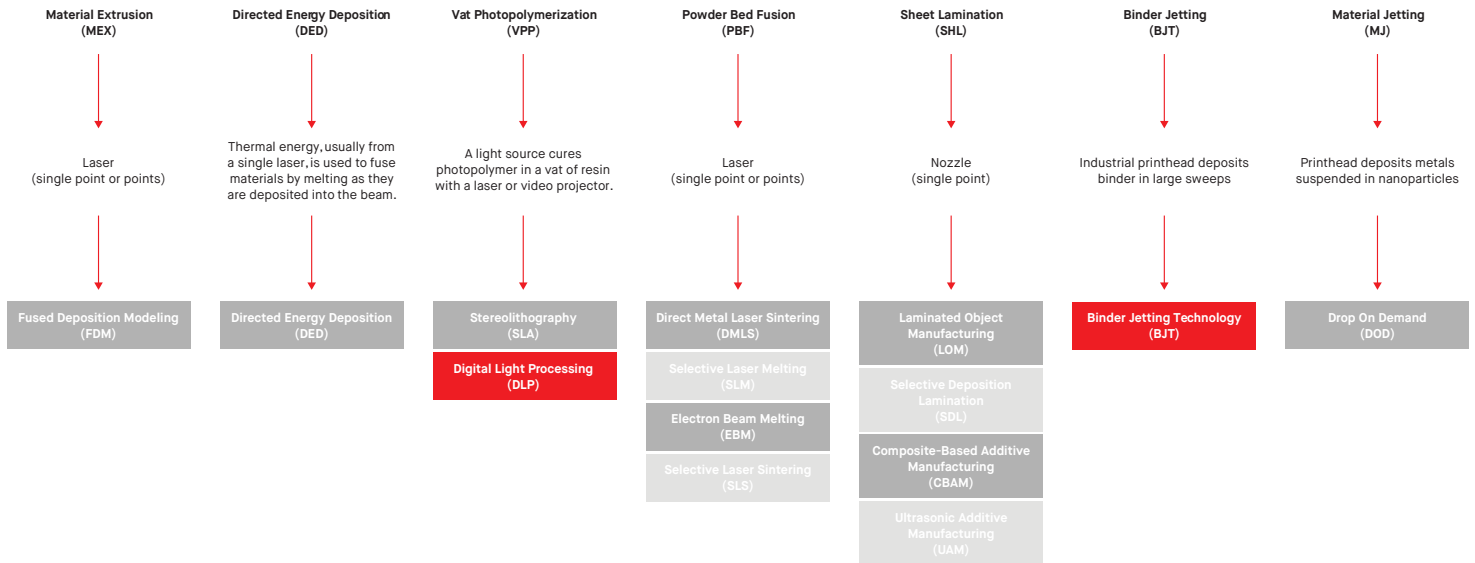

It's also why Desktop Metal has invested so heavily in area-wide DLP and BJT printing as these solutions are most capable of delivering an Additive Manufacturing 2.0 future.

Today, this area-wide approach, combined with advances in machine technology, software, and materials science, delivers DLP systems that truly compete with injection molding of thermosets and even offer amazing advantages, such as 3D-printed expanding foams.



DLP = Speed

The advantages of area-wide 3D printing techniques versus a single point approach with a laser

DLP: 1 Part	1.5 hours
SLA: 1 Part	3.25 hours
DLP: 8 Parts	1.5 hours
SLA: 8 Parts	7 hours

Machine Design

While the first SLA printers used a laser beam positioned above a vat of resin, SLA printers today feature lasers stationed either above or below the vat. Generally, top-down SLA systems are used for more industrial applications, while the bottom-up systems that came later lend themselves to smaller, more affordable desktop units.

By contrast, DLP printers have historically positioned the projector below the vat. The first commercial DLP printer, the EnvisionTEC Perfactory, used this approach, as do the vast majority of DLP printers on the market today.

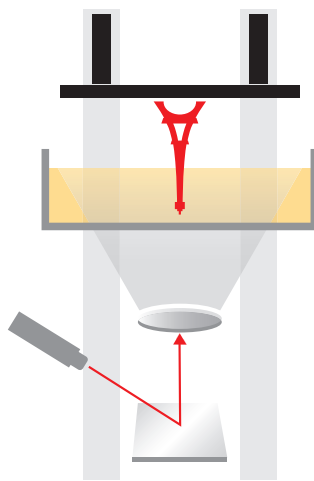

Bottom Up DLP Process
Front View

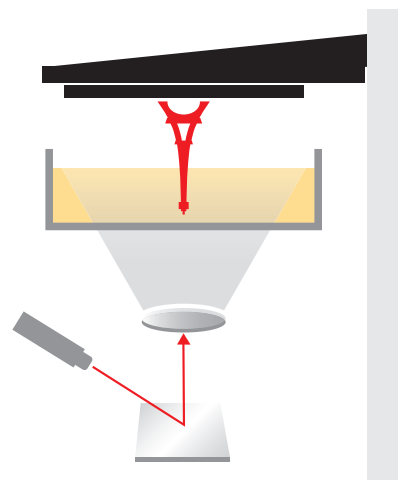

Bottom Up DLP Process
Side View

Bottom-Up DLP Printing

The reason why the projector is often stationed below a vat in DLP printing is so the light or energy from the projector can transmit through the bottom of the tray onto the resin and the layer height can be quickly and tightly controlled.

The tray in the DLP process is typically made with a clear or transparent bottom that allows for the transmission of light from the projector to the resin it's holding. A build plate moves vertically up and down in the z-axis and presses into the vat of resin, creating a thin layer of resin between the build plate and the bottom of the vat.

This thin layer of resin, controlled to between 25 and 150 microns, is what is cured during the light exposure by the projector. For this reason, perfectly parallel movement of the build plate in the z-axis is critical for

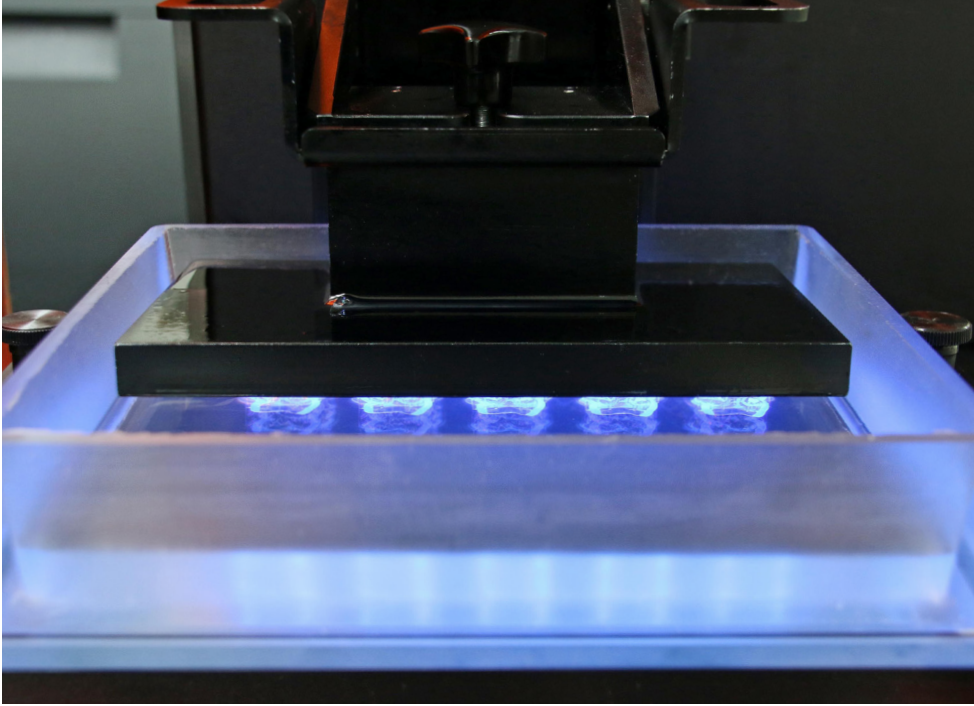

— This photograph shows the earliest stages of a DLP build job on an ETEC 3D printer, in which the material has been “burned” or adhered onto the build tray, which will move vertically upward as the build job advances. At the conclusion of the print job, the parts will be removed from the build tray.

part accuracy across each layer, leading some high-end machines to feature a dual guide rail, versus the more common single center rail which may allow the build plate to tilt to the left or right, causing issues with print accuracy.

After an initial burn layer is established to essentially stick the print design to the bottom of the plate, the build plate lifts up in the z-axis, pulling the cured layer off the floor of the vat. This allows the next layer of liquid resin to seep under the build plate during a material coating

process, after which the build plate again pushes down into the resin to reposition itself for the next layer. Pulling the cured layer of resin off the floor of the vat typically requires some effort because of suction, or “separation”, forces caused by partial bonding of the cured layer to the vat floor.

This entire multi-step process of illumination, pulling, recoating, and repositioning can be executed very rapidly. An onlooker would essentially see the build plate moving up and down very quickly as the build plate pulls the part off the tray floor or film and then lowers down to print the next layer.

Still, there is some inefficiency in the process, as it takes time for the resin to seep under the build plate and for the build plate to be repositioned accurately. Historically, engineers have had to study these dynamics and program a build style, or process parameters, to print each different material based on its viscosity, which must be relatively low to facilitate the resin seeping under the plate quickly during recoating, as well as the separation forces the material creates when the build plate pulls parts off the vat floor.

While many DLP printers today still process parts using this up-and-down process, the premium end of the market has continued to innovate for efficiency.

New Efficiencies in DLP Machine Design and Process

A major innovation in the DLP process arrived through a key machine design change that took place in 2015.

Instead of the up-and-down motion of the build plate to allow recoating between curing layers, the market introduced an innovation that used a layer of oxygen, delivered through an oxygen-permeable film on the bottom of the resin tray, to eliminate the need to separate each cured layer from the bottom of the build tray and then reposition the build plate in order to print the next layer.

By deploying an oxygen layer in the bottom of the tray, a “dead zone” was created where parts don’t stick to the tray but only to the previously printed layer. With no need to pull each layer from the vat floor, the build plate could move continuously upwards, resulting in faster prints.

While there are many different branded approaches to this innovative use of oxygen, EnvisionTEC’s version of this continuous printing technology, called CDLM, or continuous digital light manufacturing, launched in 2016. Five years later, the company unveiled an even more affordable solution to this challenge.

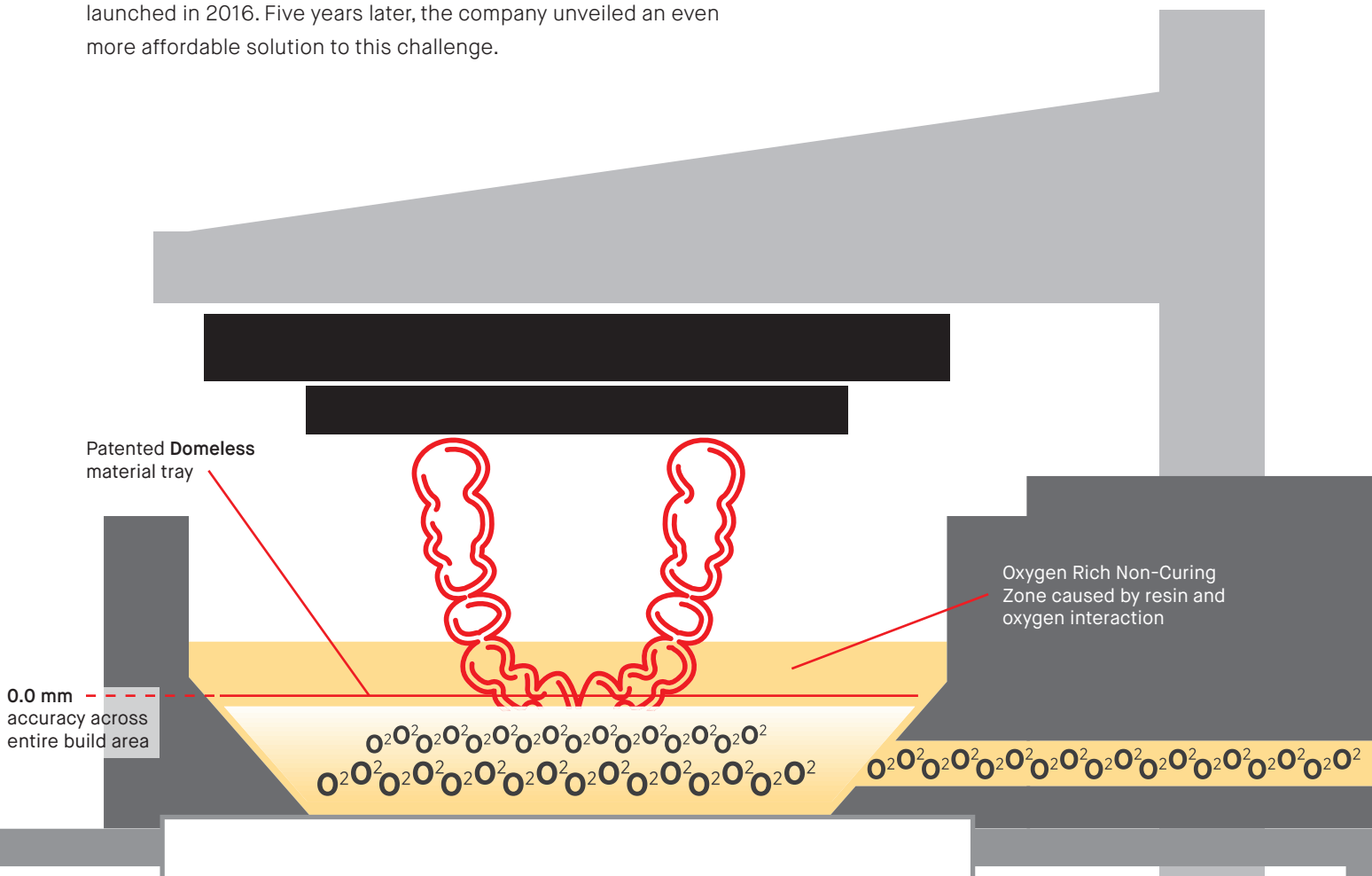

Hyperprint™ Technology

Super-fast 3D printing technology without oxygen, at speeds up to 50% faster than prior DLP technology

Hyperprint

This combination of heating, CLP sensors and a precise software control system enable a fast new way to deliver super speeds without the need for oxygen systems.

On-Board Heating

Thins the viscosity of polymer resins for quick recoating. No separate heating unit needed.



CLP Load Sensors

Closed-loop load sensors know the exact moment the current print layer is done, and fully separated from the tray floor, so the next layer can start faster.



The Launch of Hyperprint™

Since its acquisition by Desktop Metal in 2021, EnvisionTEC's DLP innovations now continue under two brands:

- **Desktop Health** equipment is developed and sold for the specific custom needs of the medical and dental market
- **ETEC** branded equipment is developed for the broader needs and materials of the manufacturing industry

First unveiled on the Desktop Health Einstein printer in 2021, Hyperprint™ is an all-new method of continuous printing that eliminates the need for an oxygen layer. While oxygen layers do work well, especially in larger DLP systems, oxygen tanks or condensing systems can add extra expense to DLP printers, as well as additional safety considerations.

Hyperprint instead uses heat, which decreases the viscosity of the resin to speed up material recoating, combined with Closed Loop Printing, with CLP load sensors, which can detect when the printed part layer has been fully separated from the film of the resin vat. This allows the Einstein printer to position the build plate quickly and accurately while moving upward in a continuous fashion without having to overextend upward and then press back down into the vat of resin. The load sensors also determine precisely how much time is needed to separate each layer versus traditional DLP printing that uses a pre-programmed longer time factor, typically based on a fully loaded build.

Hyperprint is limited to smaller build areas, which have lighter separation forces than large build areas. Einstein's Hyperprint is an affordable and effective solution for high-speed DLP printing needed by dental labs and offices, for example, to deliver high quality parts to patients quickly and accurately. This smart approach replaces the previous up-and-down motion efficiently without the need for special oxygen inputs.

Top-Down DLP

After 20 years of DLP printing from the bottom up, the 3D printing market is starting to appreciate the limitations of positioning the projector below the build area for high-volume, industrial production.

For one, there's a limit to how many parts and how much weight can be suspended vertically from a build plate when printing bottom-up. More importantly, however, the bottom-up printing approach forces serious constraints on the types of resins that can be used. Because the resin in the bottom-up approach must flow back under the build plate easily and quickly during recoating, it must be a relatively low viscosity. This limits the final material properties the resin can deliver, which will be covered later in this white paper.

Conquering the throughput limitation of standard DLP printing and delivering more durable, resilient material properties led ETEC to launch the Xtreme 8K top-down DLP printer. This next-generation machine features two industrial overhead projectors stationed above the resin vat, which allows the Xtreme 8K to offer the largest DLP build area — 166,950 mm² (450 x 371 mm) — among commercially-available, production-grade DLP printers, as well as two intense and direct light sources that don't have to penetrate through a vat film or tray, enabling printing of new materials with higher energy requirements for curing.

This innovative machine design has unlocked the ability to print large parts and print in high-volumes with DLP printing as well as new materials that directly compete with thermosets used in traditional plastic injection molding.

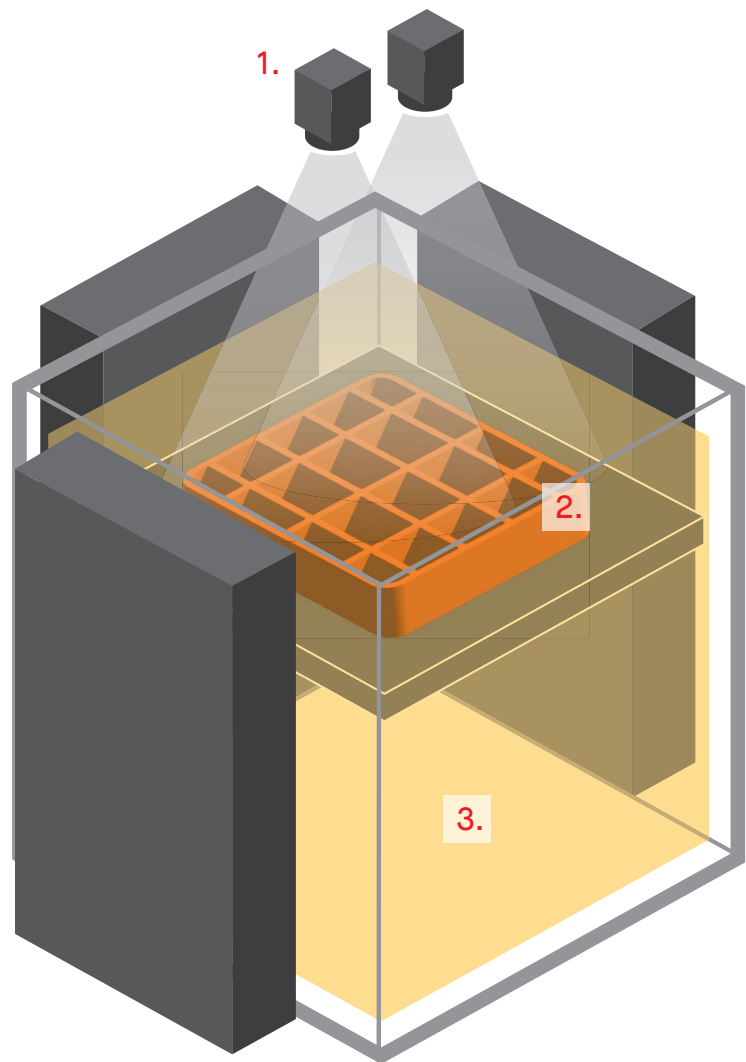

1. Top-down DLP printing expands the benefits of this technology to larger formats and a wider range of materials. The Xtreme 8K features two industrial DLP printers.

2. With top-down DLP printing, parts do not need to be burned into or affixed to the build plate. This allows for faster removal and higher throughputs. It also allows for the printing of much heavier parts that could not easily be suspended from a standard DLP build tray.

3. Because it's a top-down DLP printer, the Xtreme 8K can accommodate a very large vat of material that can be either a low or high viscosity and thus deliver a wider range of material properties. The build envelope on the 8K is 450 x 371 x 399 mm (17.72 x 14.61 x 15.71 in)

The Importance of the Light Engine

While positioning of the light source and the process for managing build plate positioning in the z-axis are critical in DLP printing, the quality of the light engine — which includes both the projector and optical train — cannot be overstated.

Different DLP chips and optical systems can lead to significant differences in the quality of rendered images, not only on 3D printers but also on televisions, for example. This is why you can sometimes see a visual difference when comparing televisions using the exact same projector resolution – say 1080, 4K or 8K.

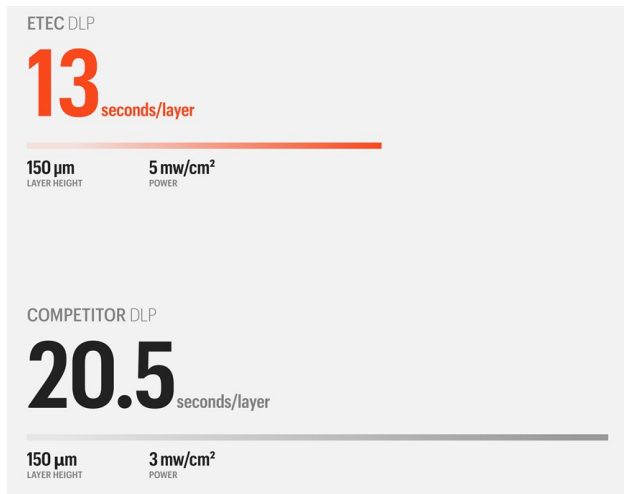

DLP chip quality can vary widely, ranging from the very inexpensive chips found in a home or office projector to extraordinarily precise and expensive systems used for curing high value aerospace coatings. ETEC only uses true industrial DLP chips that are designed for the 3D printing process and provide much higher contrast ratios than more inexpensive alternatives, ultimately resulting in crisper part details and more accuracy.

To achieve the best possible performance, these industrial chips can also be optimized to work with specific wavelengths of light. Since resins printed with DLP are UV-curable, the projectors and chips used in

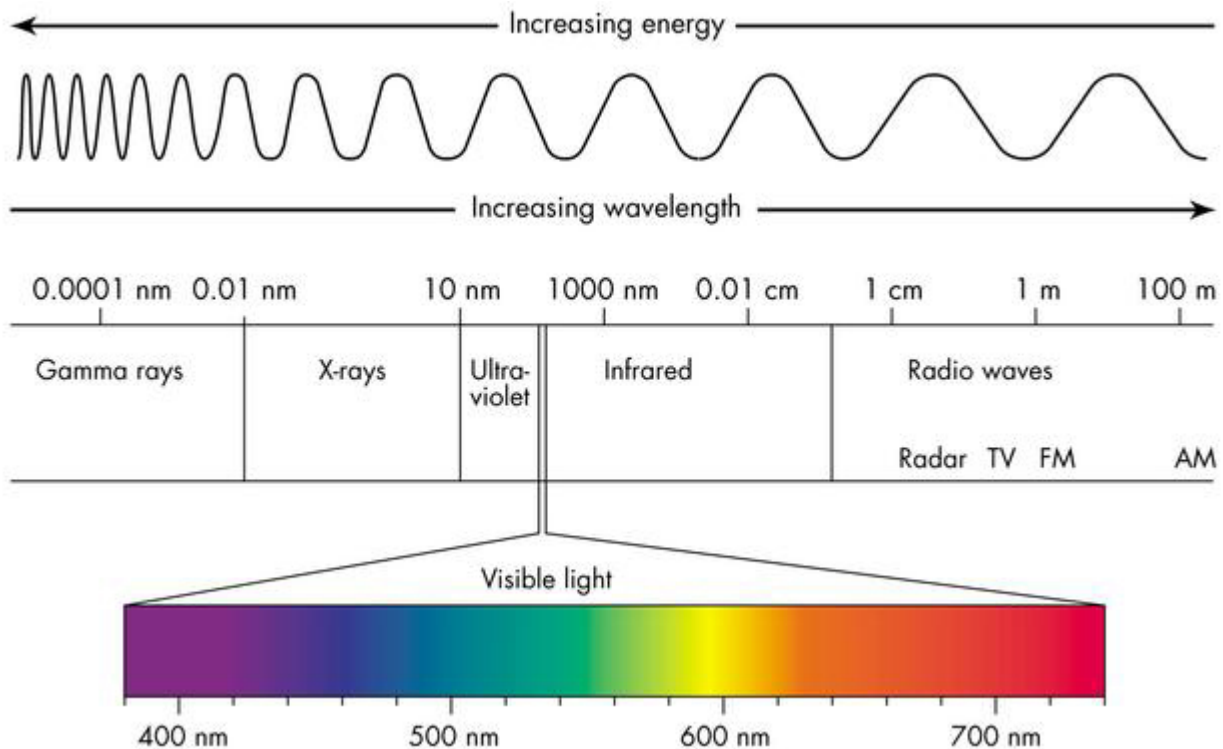

ETEC systems are designed to work at 385 nm, a true ultraviolet wavelength, which is outside the visible light spectrum. Some 3D printing systems, even with higher projector resolution, deliver inferior part quality by using a lower frequency wavelength, such as 405 nm.

Just as with the projectors and DLP chips, many companies attempt to reduce system costs by using off-the-shelf components to create their optical trains, resulting in lower-quality light engines and inferior part quality. To ensure best-in-class finish and part accuracy, some printer vendors, including ETEC, rely on high-quality, custom-designed optics which are built and coated for UV wavelengths to ensure maximum power is delivered to parts with minimal distortion.

In a bottom-up machine design, the material used for the bottom of the vat also makes a big difference in how well the light is transmitted from the projector to the resin for curing. Some plastic vat trays wear out over time from repeated build plate movement and resin flow, becoming hazy and impeding their ability to transmit light thereby diminishing part quality. In contrast, bottom-up DLP systems from ETEC and Desktop Health use a high-quality optical film placed with precision in a tray with industrial-quality steel sidewalls.

In addition, projector and DLP chip technology have progressed over time, mimicking the pattern of Moore's Law, with significant advancements occurring every 3-5 years. The advancements in projection have delivered both higher resolution and higher power, with the raw power output of DLP projectors increased eight times in the last decade – growing to more than twelve times when leveraging the Xtreme 8K's projection array technology, which is detailed later in this guide. This leap in power drastically reduces print times and enables the use of long chain molecule chemistry, which in turn produce stronger, tougher and more durable materials that rival the properties of widely used thermoplastics and elastomers.

385nm



405nm



The custom optical system used in the ETEC Envision One.

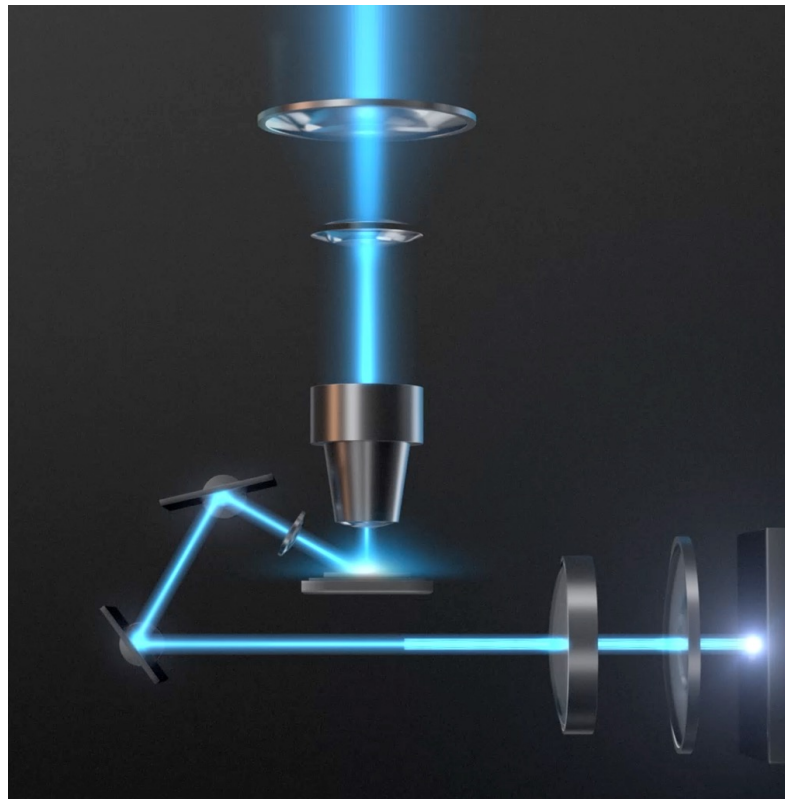

Coupled with the DLP chip and projector is an optical train that ensures the light is being precisely and accurately transmitted from the projector to the chip and then to the build chamber.



Higher resolution projectors deliver smaller, more resolute pixels for the same build size and can also print in larger print beds while maintaining high quality. However, not all 4K projectors deliver the same light quality from one projector to another as there are a wide range of considerations in the light engine.

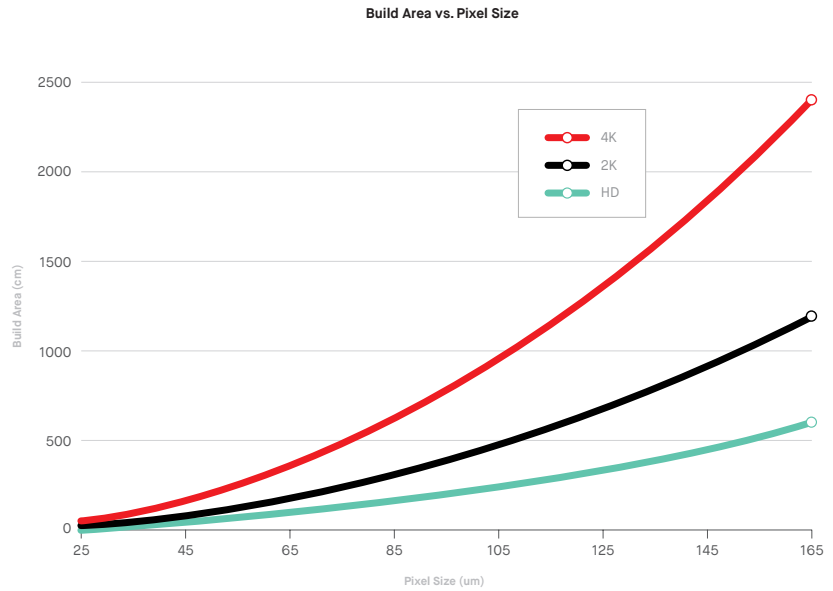

Process Considerations

Once you have learned your physical way around a DLP machine and the light engine, understanding the DLP process really comes down to a basic knowledge of pixels and voxels.

Pixels – a common term in photography – are the building blocks of a digital image in the xy-plane, such as one flashed by a DLP printer to cure a specific layer of a build, and are usually a square or rectangular in shape. Typically, the higher the number of pixels mapped to a given area, the higher the resolution. As an example, a TV with 4K resolution looks sharper than a TV with HD resolution because it has 4 times as many pixels spread across the same area.

Voxels are simply the 3D version of pixels. In DLP printing, voxels are created as the energy from the projector penetrates the pixel vertically in the z-plane in a vat as a layer cures. But with today's high-end technology, a pixel doesn't need to have sharp edges at all.

From Pixels to Voxels

Let's take the ETEC P4K Pro, which uses a native 2560 x 1600 projector with 2,560 pixels in the horizontal axis and 1,600 in the vertical y-axis.

Although all versions of the P4K Pro printer use the same projector, each offers a different build areas. The smaller the build area, the smaller the size of each pixel leading to improved resolution, and vice versa.

So, let's take the P4K Pro 35, which offers a build area of 90 x 56 mm. The pixel size is a square 35 μm in both X and Y, a number determined by simple math:

- X Resolution = 90 mm / 2560 pixels or 35 μm
- Y Resolution = 56 mm / 1600 pixels or 35 μm

P4K 35

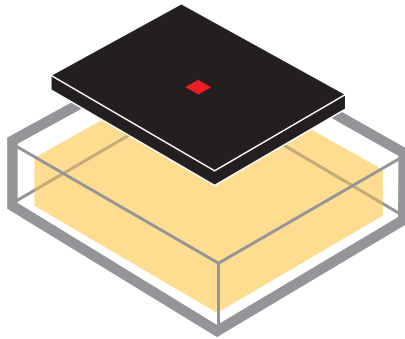

On the P4K 90, however, the build size is 230 x 144 mm, and the pixel size is 90 μm .

- X Resolution: 230 mm / 2560 pixels = .090 mm = 90 μm pixel size
- Y Resolution: 144 mm / 1600 pixels = .090 mm = 90 μm pixel size

P4K 90

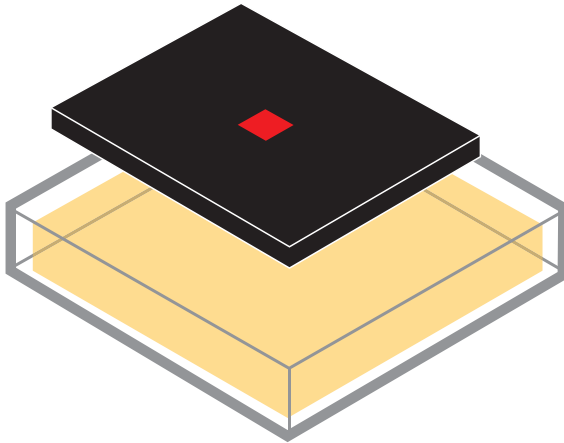

While the light from the projector is patterned into pixels across a bed, it also creates a volumetric pixel as the energy penetrates into the full depth of the print layer. As a build project grows and the amount of energy also penetrates that voxel to bind it to the prior layer. The depth of this binding is determined by the intensity of energy in each pixel as well as the exposure time.

In some systems, layer to layer bonding is weak. Complete curing is sometimes done outside the printer in a curing unit after the part has been fully formed.

Anti-Aliasing and Pixel-Shifting Technology

While a smooth surface is a requirement for many parts, creating it can be a challenge when you are using square pixel building blocks. Older DLP systems often created a jagged edge, sometimes called “stair stepping” in the industry, similar to the images of a low-resolution, pixelated 1980s arcade game.

While it may be less noticeable on smaller parts, stair-stepping becomes more pronounced as the size of printed objects and build volumes increases, which has led many manufacturers to develop methods for its mitigation.

Today’s more advanced DLP chips can deliver pixels with more sophistication than simply turning them on or off. By tightly controlling

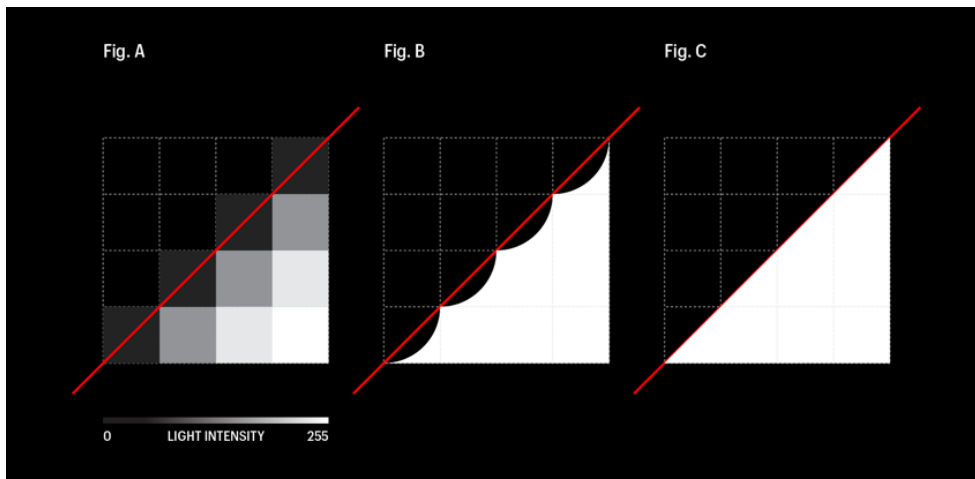

the intensity of the light energy to each individual pixel, projectors can create soft and smooth edges, eliminating the stair-stepping effect. In the digital world, this so-called anti-aliasing technology has become so ubiquitous that pixelation has been reduced to a point that cannot be discerned by the human eye. In 3D printing, these techniques help to deliver a smooth surface finish, regardless of whether a part has straight or curved edges.

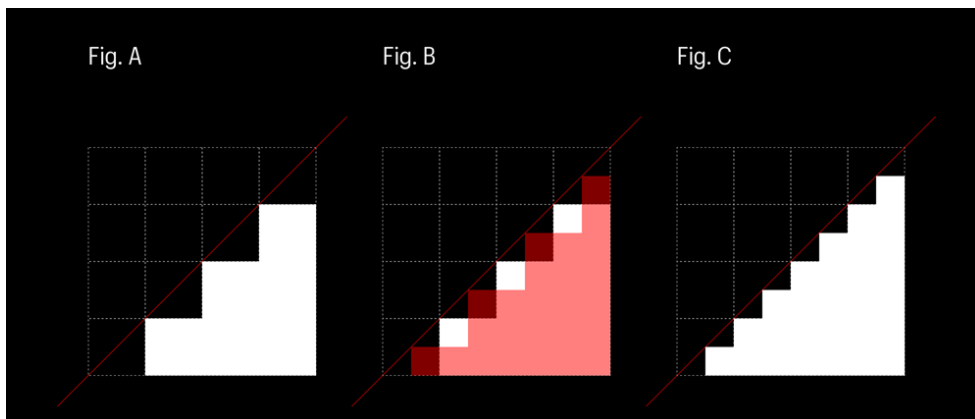

Since voxels grow from the center of a part to the edges, applying less power to these outside pixels also slows the polymerization reaction, ensuring the

resulting voxels only grow to the edge of the part and not beyond, resulting in a surface finish that requires little to no post-processing

ETEC takes this sophistication even further with pixel-shifting technology. By moving pixels at the edge of a part half a pixel in both the X and Y directions through an electromechanical stimulation of the projector, stair stepping is even further cut in half. This results in significantly improved surface finish from a lower resolution projector – especially in combination with sophisticated grayscale technology from the DLP chip.

Understanding Photopolymer Materials

Many of the initial low-viscosity photopolymers resins used in VPP – whether DLP or SLA – were derived from the protective coatings industry, where they were applied in ultra-thin layers and then cured with UV lights.

These liquid resins are typically made up of three components:

- Monomers – compounds of a single repeating chemical unit that can react with other monomers to form very large molecules, or polymers.
- Oligomers - intermediates in the polymerization reaction made up of a small number of repeated chemical units (but not nearly as much as a polymer).
- Photoinitiators - molecules that create reactive species, like free radicals, cations or anions, when exposed to visible or UV radiation

During curing, the monomers and oligomers are crosslinked, or chemically bonded to form a polymer, through the free radical polymerization process, which consists of three main steps. First, the photoinitiators react with UV light to produce free radicals, triggering the polymerization reaction. Free radicals then drive the formation of covalent bonds between reactive molecules, causing the polymer chain to grow. When nearly all reactive molecules are bonded, polymerization ends.

While these early photopolymer resins rapidly cure and offer good surface finish, they tend to be brittle and prone to cracking and shattering, offering poor impact resistance and little of the toughness and resilience needed to compete with today's traditionally manufactured plastics. Their performance also tends to degrade over time or as parts are exposed to light and hot or cold temperatures.

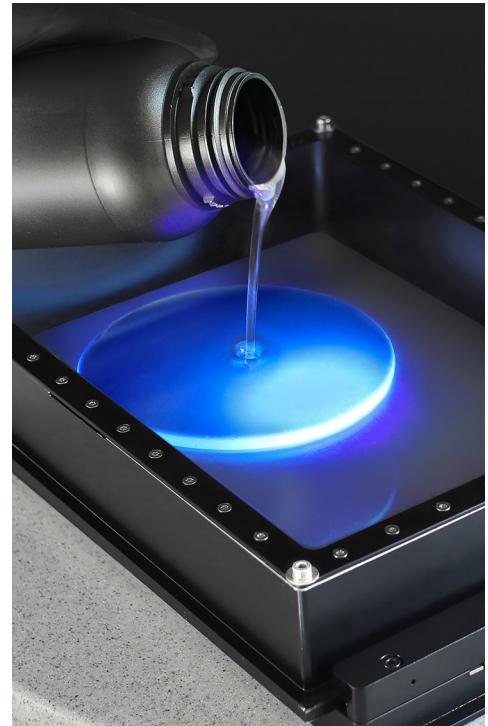

These performance hurdles are rooted in the fact that, when photocured, low-viscosity acrylates with shorter molecular chains tend to quickly form inhomogeneous polymer architecture with high crosslink density that doesn't offer the flexibility to return to its original state after stress and strain, preferring to crack or shatter instead.

For decades, the field of polymer AM has been working to enhance the material properties of the acrylates and methacrylates used in photopolymer resins for specific applications in an effort to overcome these hurdles and deliver more resilient, elastomeric properties.

One approach has been to translate two-part epoxy systems to acrylates to improve properties, often taking advantage of additives, monomers or polyurethanes that can help improve mechanical properties. While these approaches have delivered impressive material properties, they often come with other drawbacks, such as a short pot-life or long post-print baking times to complete curing.

A Breakthrough New Category of Photopolymers



—
Aerosport Additive 3D prints DuraChain™ resins on the ETEC Xtreme 8K. Located outside of Columbus, Ohio, Aerosport is a premium service bureau for 3D printed and other types of polymer, metal and fiber-reinforced parts for prototypes and production.

DuraChain is a new category of materials invented by Adaptive3D, a subsidiary of Desktop Metal, to solve these problems.

Founded in 2015 out of the University of Texas at Dallas with funding from the Defense Advanced Research Projects Agency (DARPA), Adaptive3D developed a proprietary and unique blend of materials that takes advantage of a specific chemical reaction process, called Photo Polymerization-Induced Phase Separation, or Photo PIPS, to deliver all-new material properties in DLP.

Founded in 2015 out of the University of Texas at Dallas with funding from the Defense Advanced Research Projects Agency (DARPA), Adaptive3D developed a proprietary and unique blend of materials that takes advantage of a specific chemical reaction process, called Photo Polymerization-Induced Phase Separation, or Photo PIPS, to deliver all-new material properties in DLP 3D printing.

When exposed to light during DLP printing, DuraChain photopolymer resins phase separate at the nano level and then cure into a resilient,

high-performance network much like legacy two-part material systems with shorter pot life. One of the challenges in printing these materials is that they contain high viscosity base oligomers — similar to honey or molasses — and miscible monomers that would not be easy to process on bottom-up DLP systems, which require more free-flowing resins.

Ultimately, this groundbreaking portfolio of photo-elastomers are finally delivering the tough and resilient properties that the market requires — with high tear strength, elongation, and toughness. What's more, this unique chemistry approach is delivered in one-pot, one-part, pot-stable chemistry. Because these materials are so viscous and produce heavy, durable parts, they currently require a top-down DLP printer for processing.

Today, DuraChain resins, which includes all the materials listed below, are printable on the ETEC Xtreme 8K:

- Elastic ToughRubber™ 90 (ETR 90) – the toughest AM elastomer on the market. ETR can already be found in parts and products that are sold on store shelves. It is perfect for shoe midsoles and heel cups, seals, door boots, bellows, foam-like lattice structures and impact parts.
- Elastic ToughRubber™ 70 (ETR 70) – A softer, stretchier ToughRubber useful when printing resolution limits of individual struts and minimum feature sizes do not allow ETR 90 to achieve the requisite soft feel via microarchitecture alone.
- Soft ToughRubber™ (STR) – Designed for functional prototypes of audio earbuds, wearable electronics, and anatomical medical models, Soft ToughRubber™ (STR) delivers a silicone feel and mechanical properties with the resolution and surface finish that DLP printing provides.
- FreeFoam™ – A new family of photopolymer resins containing a heat-activated foaming agent. After printing a design in FreeFoam, the part is expanded during foaming in an oven, creating a closed-cell foam with tight dimensional accuracy, and customizable for a variety of Shore A hardness values.



—
This is the inside of an Xtreme 8K 3D printing FreeFoam™, a revolutionary expandable 3D printing resin designed for volume production of foam parts. It's part of the DuraChain family of photopolymers printable exclusively on the ETEC Xtreme 8K top-down DLP printer.



Application Examples

PCB Housing

Injection mold tooling for a small part like this PCB housing typically starts at around \$10,000, with an additional cost of \$1 to \$2 per shot. With those upfront costs, an injection molding tool would not break even unless this part were made in volumes of at least 5,000.

With the Xtreme 8K, using 80 percent of the build volume, as many as 3,500 of these housings can be produced per week, at a cost of \$3.25.

Printing this part rather than injection molding removes the need to amortize tooling, and allows per-part costs to stay flat. In addition, because DLP enables a digital inventory—storing parts as digital files — means the cost of storing spare or replacement parts and maintaining tooling are eliminated by storing parts as digital files and producing inventory on-demand.

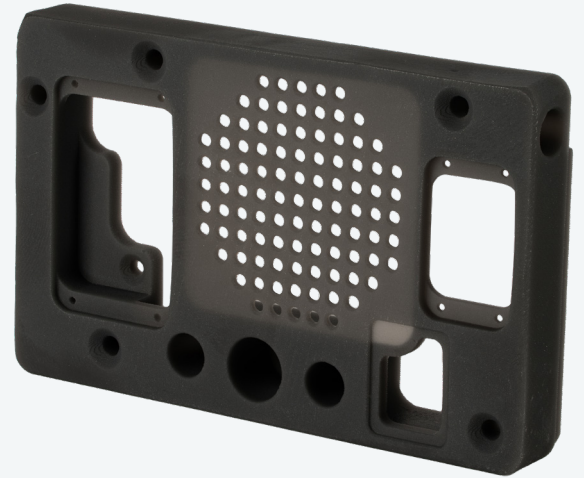

Flow Adapter Housing

This housing holds a mass air flow sensor so it can be bolted to the rest of a vehicle assembly. Produced as a replacement for legacy parts which are no longer in production or inventory, this housing was needed in relatively low volumes - just a few hundred parts per year.

Due to those low volumes, the manufacturer couldn't justify investing in replacement injection mold tooling, as the cost of tooling would drive up the part cost. With DLP, the exact quantity of needed parts can be printed, on-demand, as orders come in.

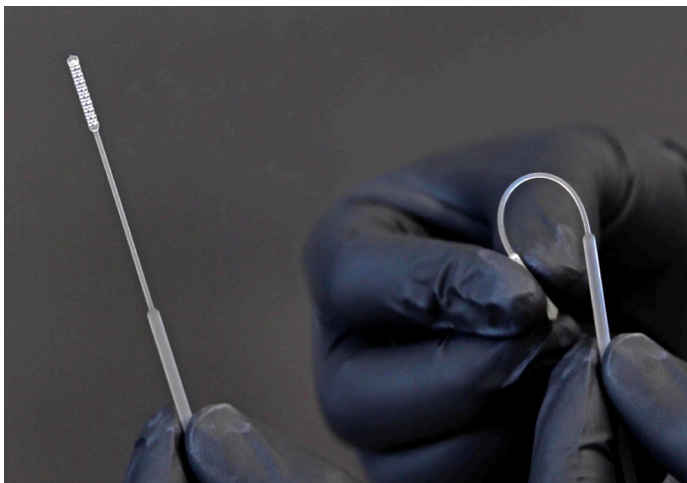
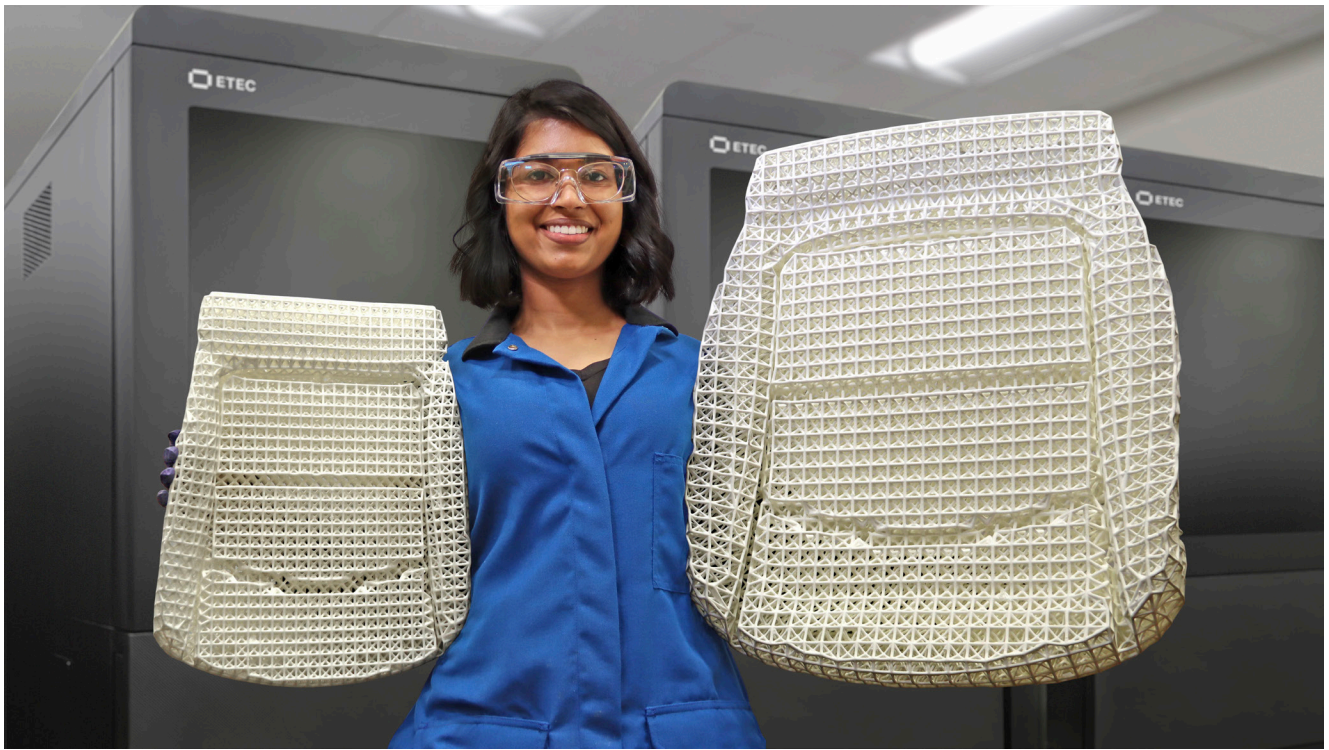

Conclusion

DLP printing has come a long way in the past three decades, and it continues to stand apart from other 3D printing processes for polymers because of its ability to process full area-wide layers in a flash.

Today's commercial DLP market is highly crowded and competitive, a dynamic that continues to drive new innovations in the field — from new machine and process design approaches to new materials. While bottom-up DLP systems dominate the field, industrial manufacturers have started to appreciate the limitations of these systems and new top-down DLP printers are expected to lead the way into the Additive Manufacturing 2.0 future.

Ultimately, new innovations in DLP have pushed the field to a place where it is now fully competitive with traditional manufacturing approaches. Advanced DLP systems offer the combination of speed, accuracy, cost, material properties and throughput needed to compete — and in some cases, beat — traditional manufacturing. They also have the ability to produce complex parts at any volume without the cost, long lead times and geometric limitations of tooling.

DLP printing and other AM 2.0 technologies are erasing or rewriting those rules, and the results will have a profound effect on how we manufacture virtually every product we use over the next decade.



Desktop Metal, Inc., based in Burlington, Massachusetts, is accelerating the transformation of manufacturing with an expansive portfolio of 3D printing solutions, from rapid prototyping to mass production. Founded in 2015 by leaders in advanced manufacturing, metallurgy, and robotics, the company is addressing the unmet challenges of speed, cost, and quality to make additive manufacturing an essential tool for engineers and manufacturers around the world. Desktop Metal was selected as one of the world's 30 most promising Technology Pioneers by the World Economic Forum, named to MIT Technology Review's list of 50 Smartest Companies, and the 2021 winner of Fast Company's Innovation by Design Award in materials and Fast Company's Next Big Things in Tech Award for sustainability. For more information, visit www.desktopmetal.com.

Desktop Metal
63 3rd Ave
Burlington, MA 01803

Desktop Health

